

WARRANTY INFORMATION

The **germstar** system comes with a 1 year limited warranty on material and workmanship. To preserve this warranty the following guidelines should be observed:

- refrain from using dispenser in extremely steamy and/or humid environments
- use only original **germstar** refill solutions
- install only "super-dry" quality, 1.5 volt, D-size batteries or better
- observe all guidelines and instructions in this booklet

Warranty becomes void under, but not limited to, the following conditions:

- if unit is forcibly damaged
- if used with other than original **germstar** refill solutions
- if battery compartment is flooded with solution

TROUBLESHOOTING

- **Unit is not dispensing and green light does not come on**
 - Make sure palm of hand is far enough backwards and about 2" (5 cm) underneath outlet
 - Make sure that batteries are of correct type and not empty (see step 10)
 - Check that batteries are properly inserted, also check polarity (see step 10)
- **Unit does not dispense product but green light comes on**
 - Check that bottle is seated firmly on middle part (see step 15)
 - Check that tip of bottle is properly cut open (see step 13)
 - Try to replace bottle and see if condition improves
- **Unit does dispense product but red light comes on**
 - Batteries are getting low and need replacement soon (see step 20)
- **Red light is constantly flashing**
 - Batteries are low and need to be replaced (see step 20)
- **Unit is very insensitive – hand almost touches bottom before activation**
 - Unit is in too brightly lit spot → try moving unit to location with more subdued lighting conditions (see step 7)
- **Unit is dripping continuously**
 - Check that bottle is seated firmly on middle part (see step 15)
 - Check that tip of bottle is properly cut open (see step 13)
 - Try to replace bottle and see if condition improves
- **Unit dispenses on its own with green light on during dispensing cycles**
 - Unit is mounted too close to surface underneath → try mounting unit higher up or above a less reflective surface (see step 7)

If above suggestions do not solve your problem, please contact either your local distributor or the **soaptronic**® headquarter listed below to obtain service and repair.

Headquarter:

soaptronic® international, LLC
20562 Crescent Bay Dr.
Lake Forest, CA 92630, USA

Toll Free 1 800 327 2606
Tel. +1 949 465 8955
Fax. +1 949 465 8962

Local distributor:



E

germstar
instant hand sanitizer

...be well

dispenser

www.germstar.com

DISPENSER, Model 12111 / Model 13111/ Model 14111

INSTRUCTION FOR MOUNTING & OPERATION

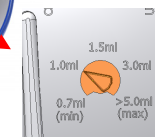
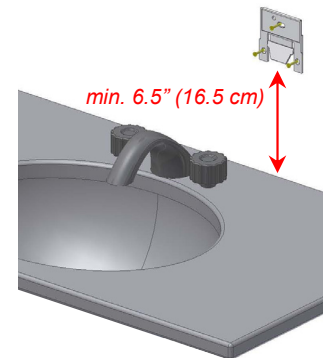
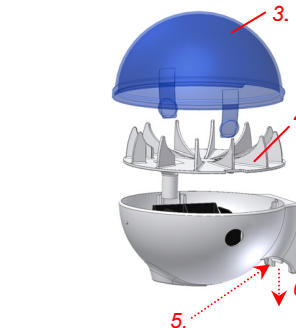
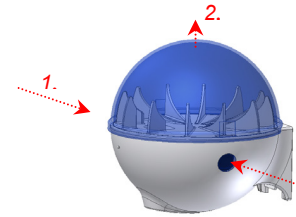

1. To open the upper globe, push both flaps located at the right and left side of the dispenser as indicated by arrows
2. By performing the action described under 1. the upper globe pops-up automatically (as indicated by arrow)
3. Remove upper globe as indicated
4. Remove middle part as indicated
5. To remove the mounting plate, push the nose inward (as indicated by arrow)
6. while pulling the mounting plate down (as indicated by arrow)

If you have a portable unit (Table- or Floor Stand), please continue with step 9.

7. When choosing a location for permanent mounting, observe the following guidelines:
 - I) Avoid direct sunlight onto the unit since the built-in infrared sensor works best in locations away from direct or strong light sources.
 - II) When mounting the dispenser over a sink or other surface, make sure that you have vertical clearance of at least 6.5" (16.5 cm) as indicated in picture.
 - III) Mount the plate on the wall using the provided screws/dowels or your own hardware as shown. Use screws or other fixtures with 3/10" (7.6 mm) heads.

8. Adjust the amount of portion using the adjustment knob located underneath the dispenser.



9. Slide the lower globe onto the mounting plate or mounting part of stand. Make sure that the rails on the plate fit into the respective grooves on the dispenser bottom. Push lower globe down until it snaps in place.

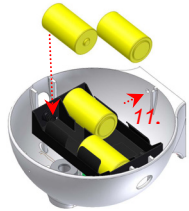

10. Use 4 x 1.5 volt D-size batteries (alkaline batteries will last longer). Put them into the battery compartment, observing the polarity as shown on the bottom of the battery tray.

If you have a portable unit (Table- or Floor Stand), please continue with step 12.

11. Push security pin (provided with the mounting hardware) into the hole in the lower globe of the dispenser as indicated. This will prevent unauthorized removal of the unit (in the future, make sure to remove this pin before trying to lift the dispenser off the mounting plate).

12. Put the middle part back on the lower globe

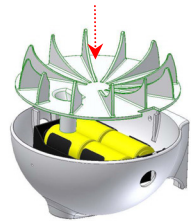

13. The close-up cap of your **germstar** solution container is designed to eliminate contamination. It allows for safe shipping and guarantees sterility when arriving from the factory.

Before inserting a new bottle into the dispenser, turn bottle upside down (appendix pointing up) as shown in picture and **cut off the plastic appendix at the tip** of the bottle by using a knife or other sharp utensil.

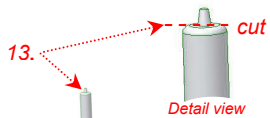

14. To prevent any spilling of the solution, seal with finger tip the new opening and turn bottle back into upright position (appendix pointing down). Since the inside valve is in position and preventing any spilling of the solution you can release the opening now.

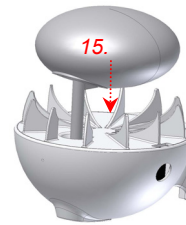
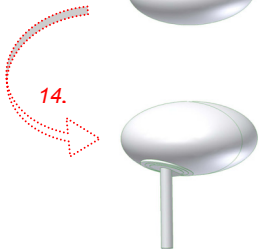

15. Insert the bottle into the dispenser through the hole in the middle part until it is seated firmly.

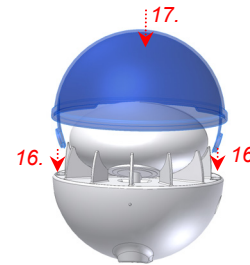

16. Put the upper globe back on the lower part by sliding the two cover flaps into the openings of the middle part (see detail view "A").

17. Push firmly until both flaps of the upper globe snap in the given opening of the lower part.

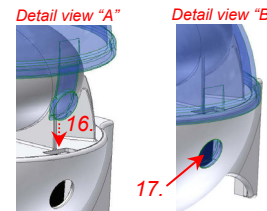

18. Now the dispenser is ready for use. It can be used with either one or two hands. To activate, place your hand about 2" (5 cm) under the dispenser. On activation, the indicator lamp on the front (indicated by arrow) will light up in **green** to signal proper operation. Leave your hands under the unit until the light goes out and the dispensing cycle is over.

19. If the dispenser is not activated the status lamp **flashes green** every five seconds, indicating proper operation.

20. When the set of batteries runs low the indicator lamp on the front flashes **red** indicating low batteries. At this time the old set of batteries needs to be replaced.

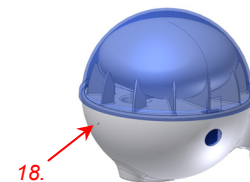

TECHNICAL SPECIFICATIONS

housing	modular construction, high impact ABS and Polycarbon materials
sensor type	reflective infrared sensor
dispensing amount	adjustable from 0.5 to 6 ml
solution capacity	cartridge system with 32 FL OZ (946 ml) per refill
power source	4 x 1.5 volt D-size "super-dry" batteries
power consumption	inactivated <1 mA, activated about 400 mA
battery life	about 1 year with alkaline batteries
dimensions (w/h/d)	7.56" (192 mm) / 7.32" (186 mm) / 7.67" (195 mm)
weight	2 lbs (w/o batteries and solution cartridge)